

**Artega<sup>®</sup>**  
**GT**



**Perfekte Linie. So schön kann sportlich sein.**

Der Artegra® GT ist ein Sportwagen, der in die Zeit passt. Kompakt, schnell und leicht – automobiler Lifestyle pur. Mit einer außergewöhnlichen Form, die der renommierte Designer Henrik Fisker gezeichnet hat. Schon vor dem Serienstart avancierte er zum Designklassiker. Jetzt können Sie den Artegra® GT auch fahren. Und den Esprit eines modernen Sportwagens spüren.

**Perfect contours. Sporty can be this beautiful.**

The Artegra® GT is a sports car worthy of the 21<sup>st</sup> Century. Compact, fast and light – a “pure” sports car that is suitable for everyday use. It has an exceptional shape, created by renowned designer Henrik Fisker. Even before it went into production, it was already a design classic. Now you too can drive the Artegra® GT and feel the true spirit of a modern sports car!

INSPIRATION



## P E R F O R M A N C E

### Weniger ist mehr. Für eine neue Leichtigkeit.

Starke Fahrleistungen durch niedriges Gewicht und nicht durch hohe Motorleistung. Der Artega® GT steht für ein neues Konzept im Fahrzeugbau mit einer eindrucksvollen Agilität. In weniger als fünf Sekunden sprintet er von 0 auf 100 km/h. Für hohe Sicherheit sorgen Crash-Module, Seitenaufprallschutz, vier Airbags und topaktuelle Fahrerassistenzsysteme.

### Less is more. A new lighter concept.

Excellent driving performance thanks more to its low weight than high engine power. The Artega® GT represents a new concept in vehicle construction with an impressive level of agility. It accelerates from 0 to 100 km/h in under five seconds. To ensure a high degree of safety, it comes with crash modules, impact protection, four airbags and cutting-edge driver assistance systems.



**Ein Unikat in Handarbeit. Höchst individuell.**

Die außergewöhnlichen Proportionen des Artega® GT sind eine Rarität. Weltweit einzigartig ist die leichte und äußerst zähe Polyurethan-Außenhaut. Die handwerkliche Fertigung im neuen Artega®-Automobilwerk überzeugt mit Individualität. Hier entstehen alltagstaugliche Sportwagen in Handarbeit. Mit viel Platz auch für die Reise und einer Reichweite von mehr als 750 km.

**Hand-crafted and unique. Highly individual.**

The remarkable proportions of the Artega® GT are a rarity. And it is the first car in the world to have a body completely made out of light, but extremely tough, polyurethane. Hand-finishing in the new Artega® automotive plant ensures this car will impress with its individuality. The result is a hand-crafted sports car suitable for everyday use. A car with plenty of space for trips and a cruising range of more than 750 km.

## S U S T A I N A B I L I T Y

### Fortschrittliche Bilanz. Auch beim Verbrauch.

Eine Materialkombination aus dem Rennsport, mit einem Aluminium-Spaceframe als Basis, macht den Artega® GT so leicht. Das geringe Leistungsgewicht sorgt für erstaunliche Verbrauchswerte. Nur 8,9 Liter\* auf 100 Kilometern sprechen für sich. Ressourcenschonende Verfahren in der Fertigung und eine hohe Recyclingquote unterstützen die fortschrittliche Ökobilanz.

### Forward-looking ecobalance. And low fuel consumption.

The Artega® GT's exceptionally low weight is down to its construction from a range of materials used in the world of racing as well as to the use of an aluminium space frame. And the low power-to-weight ratio means astoundingly low fuel consumption which, at just 8.9 l/100 km\*, speaks for itself. Resource-saving procedures in production and a high recycle rate add to this car's forward-looking ecobalance.

\* Durchschnittsverbrauch nach EURO 4-Norm

\* Average consumption compliant with the EURO 4 standard



**Artega**  
GT



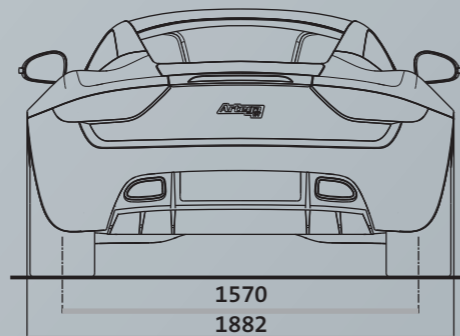
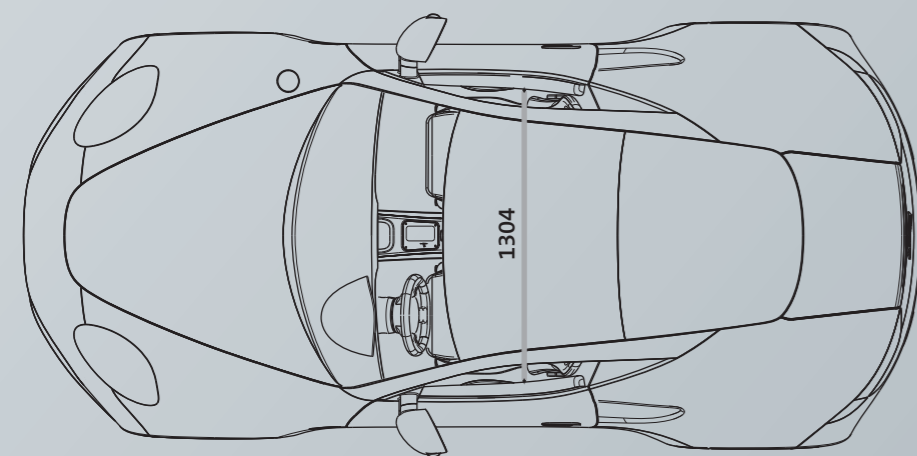
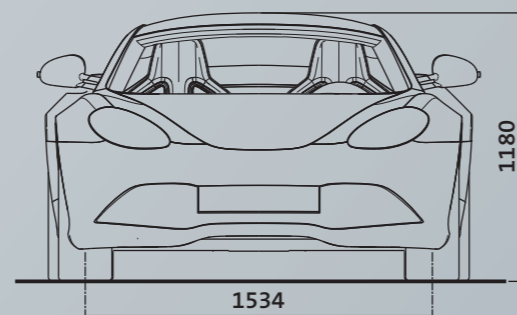
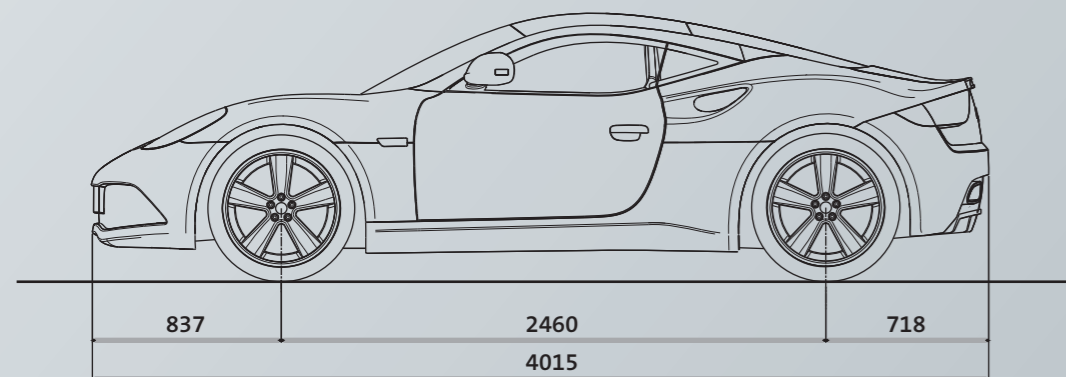

**Starke Leistungsdaten. Fahrspaß ohne Ende.**

Motor:	V6 Direkteinspritzer im Heck
Hubraum:	3597 ccm
Leistung:	220 kW (300 PS)
DIN Leergewicht:	1285 kg
Zulässiges Gesamtgewicht:	1495 kg
Leistungsgewicht:	4,28 kg/PS
Getriebe:	Sechsgang-Direktschaltgetriebe
Beschleunigung 0–100 km/h:	4,8 s
Höchstgeschwindigkeit:	270 km/h
EU-Normverbrauch (Euro 4):	8,9 l (Super Plus ROZ 98)
CO <sub>2</sub> -Emissionen:	220 g/km
Reichweite (ca.):	765 km
Rahmen:	Aluminium-Spaceframe, Heckmodul als Gitterrohrrahmen aus hochfestem Stahl
Karosserie:	Kohlefaserverstärkte Kunststoffe
Abmessungen (L x B x H):	4015 x 1882 x 1180 mm
Radstand:	2460 mm
Kofferraumvolumen:	300 l

**High performance data. Endless driving pleasure.**

Engine:	V6 direct injection rear-mounted
Capacity:	3597 cc
Power output:	220 kW (300 PS)
DIN kerb weight:	1285 kg
Gross vehicle weight rating:	1495 kg
Power to weight ratio:	4.28 kg/PS
Transmission:	Six-speed direct transmission
Acceleration 0 – 100 km/h:	4.8 s
Top speed:	270 km/h
EU-standard fuel consumption (Euro 4):	8.9 l (Super Plus ROZ 98)
CO <sub>2</sub> emissions:	220 g/km
Range (approx.):	765 km
Chassis:	Aluminium space frame, high-tensile steel tube frame rear module
Bodywork:	Carbon fibre reinforced plastic
Dimensions (L x W x H):	4015 x 1882 x 1180 mm
Wheel base:	2460 mm
Luggage space:	300 l

D I V E R S I T Y

Optimale Farbabstimmung. Ganz nach Wunsch.

Optimal colour matching. Highly customisable.

Lackierungen | Paintwork

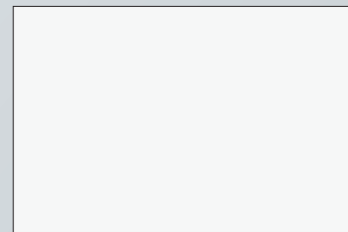

Schneeweiß



Feuerrot

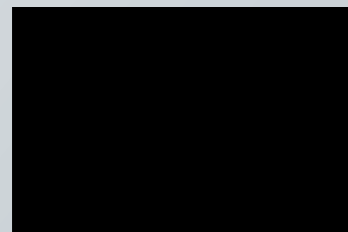

Nachtschwarz



Gletschersilber metallic\*

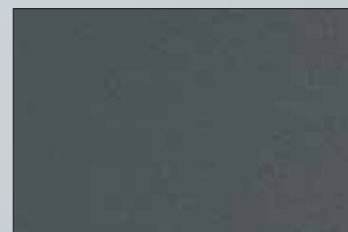

Rauchgrau metallic\*



Ozeanblau metallic\*

Sitzbezüge Microvelours | Seat covers Microvelours

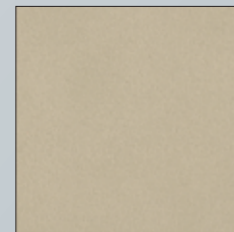

Pergamentbeige



Kirschrot

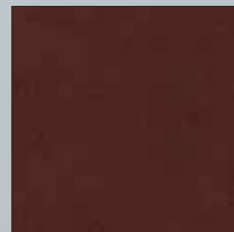

Tabakbraun

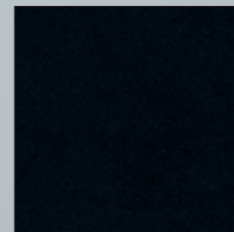

Carbonschwarz

Sitzbezüge Leder\* | Seat covers Leather\*

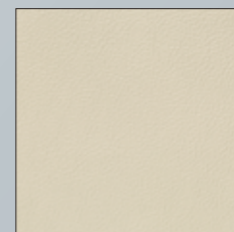

Pergamentbeige

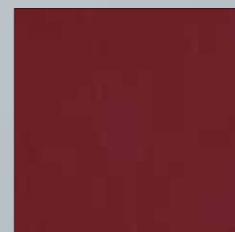

Kirschrot

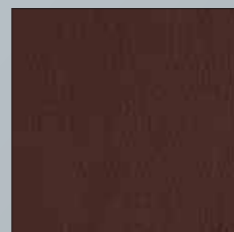

Tabakbraun

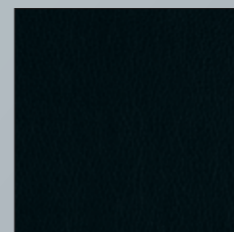

Carbonschwarz

Dachhimmel | Roof lining

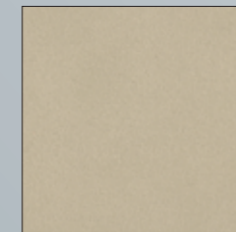

Pergamentbeige

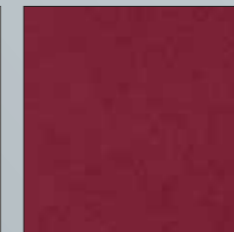

Kirschrot

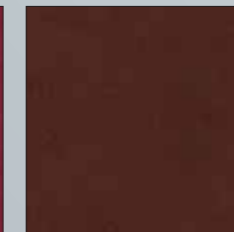

Tabakbraun

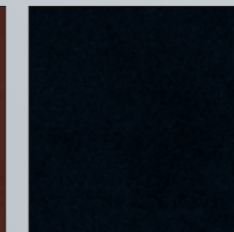

Carbonschwarz

Teppiche | Carpeting

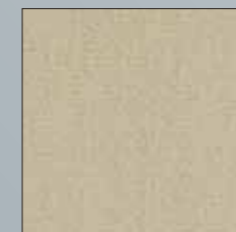

Pergamentbeige



Kirschrot

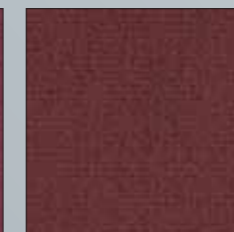

Tabakbraun

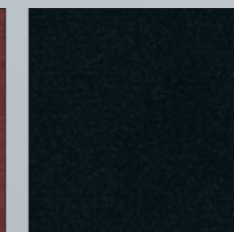

Carbonschwarz

Schmiede-Räder | Forged rims



**5-Speichen | 5 spokes**  
silber | silver  
vorne | front 8" x 19"  
hinten | rear 9,5" x 19"



**5-Doppelspeichen\* | 5 double spokes\***  
(Gewichtsvorteil | weight advantage)  
grau-metallic | grey metallic  
vorne | front 8" x 19" · hinten | rear 10,5" x 19"



**Winter\* | winter\***  
silber | silver  
vorne | front 8" x 18"  
hinten | rear 9,5" x 18"



**5-Doppelspeichen\* | 5 double spokes\***  
(Gewichtsvorteil | weight advantage)  
silber poliert | silver polished  
vorne | front 8" x 19" · hinten | rear 10,5" x 19"

**Artega**<sup>®</sup>  
www.artega.de

